

BKX Round Junction Boxes

CEC:
Class II, Division 1 and 2, Groups E, F, G
Class III
CSA Enclosure 4

COMMERCIAL AND INDUSTRIAL FITTINGS: CONDUIT OUTLET BODIES

Applications

- Serve as pulling fittings.
- Provides openings for splicing.
- Connect and change direction of conduit runs.
- When used with a gasket, BKX junction boxes are weatherproof.
- BKX junction boxes are dust-ignitionproof when supplied for Class II applications. Suitable for use in grain elevators, flour mills and other environments where dust presents a hazard.

Features

- Malleable iron Unilets™ offer high tensile strength, ductility, corrosion resistance and impact and shock resistance.
- Copperfree aluminum Unilets™ are lightweight, self-oxidizing, self-renewing and offer a high corrosion resistance.
- Roomy interiors: more wiring space.
- Smooth, rounded integral bushing in each hub protects conductor insulation.
- Accurately tapped, tapered threads for tight, rigid joints and ground continuity.
- BKX Series
 - Enclosed and gasketed boxes when used with hub or blank covers provide CSA Type 4 fit.
 - Suitable for exposed or concealed installations.
 - Boss in rear of box allows for fifth entry, factory or field entries, 1/2" or 3/4".
 - Available in three inside depths: 1-1/2", 2-1/4" and 3".
 - Furnished with four tapped holes and two close-up plugs.
 - Available in gray iron and aluminum.
 - Cushion fixture hangers are enclosed and gasketed.
 - Available for Class II, Division 1 applications.
 - Can be fitted with terminal block.

Standard Materials

- BKX junction boxes and cast covers: gray iron
- BKX-A junction boxes and cast aluminum covers: copperfree (max. 4/10 of 1%) aluminum
- BKX sheet metal covers: steel or aluminum
- Gaskets: neoprene or composition fiber

Standard Finishes

- Boxes and covers: triple-coat — (1) zinc electroplate, (2) chromate and (3) epoxy powder coat

Options

- Factory installed terminal block, add suffix **-CB** to catalog number

CEC Certifications and Compliances

- CSA Standard: C22.2 No. 18.1
- CSA Certified: 013017

Related Products

- For explosionproof junction boxes, see Enclosures and Junction Boxes.
- For Class II Fixture Hangers, See *Lighting*.









BKX Junction Boxes.
Choice of three depths.

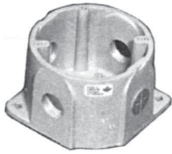

BKX Class II Junction Boxes with covers and gasket.

BKX Round Junction Boxes

CEC:
 Class II, Division 1 and 2, Groups E, F, G
 Class III
 CSA Enclosure 4



	Description	Hub Size (Inches)	Catalog Number	
			Aluminum	Gray Iron
	BKXS – 1-1/2" Inside Depth Furnished with four tapped holes and 4" centers, two tapped holes on 3-1/2" centers, four tapped conduit entries and two close-up plugs. Order covers as separate item.	1/2	BKXS-1A	BKXS-1
		3/4	BKXS-2A	BKXS-2
	BKXM – 2-1/4" Inside Depth Furnished with four tapped holes on 4" centers, two tapped holes on 3-1/2" centers, four tapped conduit entries and two close-up plugs. Order covers as separate item.	1/2	BKXM-1A	BKXM-1
		3/4	BKXM-2A	BKXM-2
		1	BKXM-3A	BKXM-3
	BKXD – 3" Inside Depth Furnished with four tapped holes on 4" centers, two tapped holes on 3-1/2" centers, four tapped conduit entries and two close-up plugs. Order covers as a separate item.	1/2	BKXD-1A	BKXD-1
		3/4	BKXD-2A	BKXD-2
		1	BKXD-3A	BKXD-3
BKX Covers – Furnished with screws				
	Cast	Blank	CBK-A	CBK
		1/2	CBK-1A	CBK-1
		3/4	CBK-2A	CBK-2
	Stamped Sheet Metal (steel)	Blank	CB-A	CB
	BKX Gasket Neoprene		—	BKG
JB – Flexible Fixture Hangers – Furnished with gasket and screws.				
	Ball Type 15° swing in all directions, supports 113.4 kg (250 lbs)	1/2	—	JBK-50-BS
		3/4	—	JBK-75-BS
	Cushion Type Enclosed and gasketed – 8° swing in all directions. Cushions 18 kg (40 lb), supports 113.4 kg (250 lbs)	1/2	—	JBK-50-CS
		3/4	—	JBK-75-CS

BKX Round Junction Boxes

CEC:
 Class II, Division 1 and 2, Groups E, F, G
 Class III
 CSA Enclosure 4

COMMERCIAL AND INDUSTRIAL FITTINGS: CONDUIT OUTLET BODIES

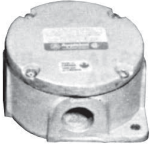
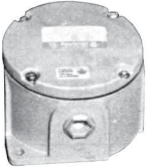
Appleton®

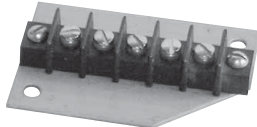
Description	Hub Size (Inches)	Catalog Number	
		Aluminum	Gray Iron
 <p>BKXS — 1-1/2" Inside Depth Furnished with cover and attached gasket, four tapped openings and two close-up plugs.</p>	1/2	BKXS-1BA	BKXS-1B
	3/4	BKXS-2BA	BKXS-2B
 <p>BKXM — 2-1/4" Inside Depth Furnished with cover and attached gasket, four tapped openings and two close-up plugs.</p>	1/2	BKXM-1BA	BKXM-1B
	3/4	BKXM-2BA	BKXM-2B
	1	BKXM-3BA	BKXM-3B
 <p>BKXD — 3" Inside Depth Furnished with cover and attached gasket, four tapped openings and two close-up plugs.</p>	1/2	BKXD-1BA	BKXD-1B
	3/4	BKXD-2BA	BKXD-2B
	1	BKXD-3BA	BKXD-3B
 <p>BKX — Class II replacement cover assemblies Cast cover with permanently affixed gasket. Furnished with screws.</p>	—	CBK-GA	CBK-G
 <p>Terminal Block Furnished with fastening hardware. 5 wire, 20 Amp, 300 Volt.</p>	—	—	CB205B

BKX Round Junction Boxes

CEC:
 Class II, Division 1 and 2, Groups E, F, G
 Class III
 CSA Enclosure 4

Dimensions in Millimeters (Inches)

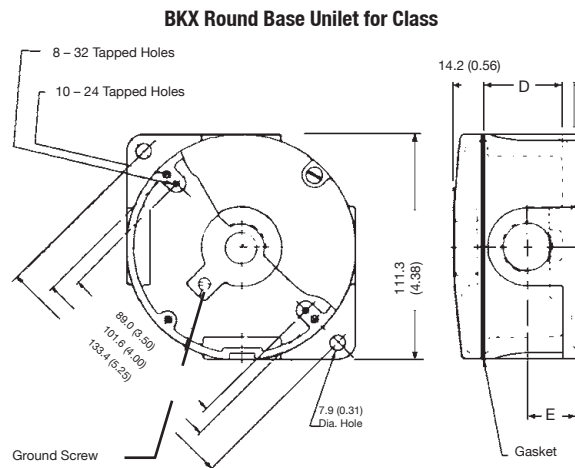
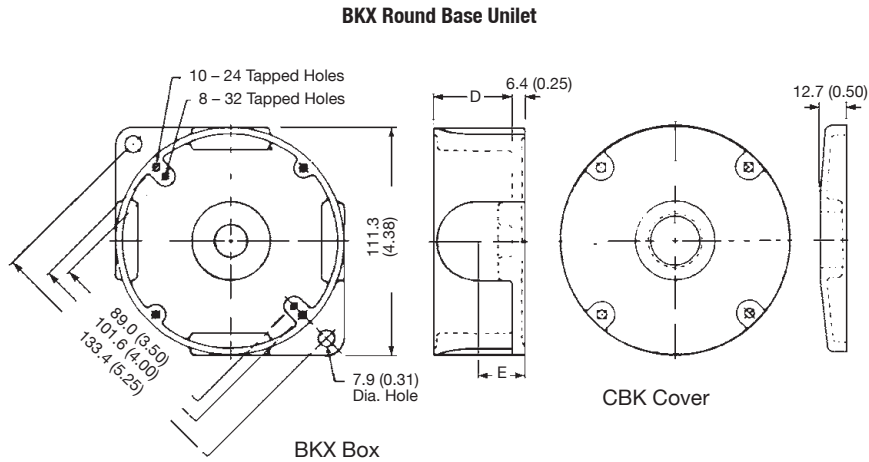

Enclosure	Dimensions in Millimeters (Inches)	
	D	E
BKXS	38.1 (1.50)	23.9 (0.94)
BKXM	57.2 (2.25)	39.6 (1.56)
BKXD	76.2 (3.00)	39.6 (1.56)